



NEURON BASE BOARD

For NVIDIA® Jetson Nano™ and Jetson Xavier NX™ Platforms

OVERVIEW

Neuron Base from Mistral is a feature-rich, performance oriented base board designed to meet the compelling needs of modern AI, deep learning and inference on the edge. Neuron Base supports NVIDIA's both Jetson Nano and Jetson Xavier NX modules and enables all the Jetson SoM features.

When used with Jetson SOM, the Neuron Base can be integrated with Mistral's mmWave Radar Modules to design camera and mmWave Radar Fusion Solutions for Industrial and Automotive applications.

With its form-factor, performance, power advantage, rich I/Os and software support, Mistral's Neuron board offers a flexible and scalable platform to get products to market faster at reduced development costs to the customers.

Interfaces and Connectivity

- ▶ Camera Connectivity: MIPI CSI (2 lane / 4 lane), FPD Link III, GMSL
- ▶ USB3.1, USB2.0, Gigabit Ethernet, HDMI 2.0
- ▶ On Board Wi-Fi 802.11 a/b/g/n/ac & BT 5.0
- ▶ M.2M key slot for NVMe SSD card
- ▶ CAN, GPIO, FAN control, 9 axis IMU sensors
- ▶ mmWave Radar interface

FEATURES

- ▶ One Architecture - compatible with NVIDIA Jetson Nano & NVIDIA Jetson Xavier NX
- ▶ Flexible and scalable platform
- ▶ Connectivity to mmWave RADAR for Sensor Fusion Application
- ▶ On Board Wi-Fi & BT 5.0
- ▶ Enabled with NVIDIA's JetPack SDK: Supports all major AI frameworks with accelerated libraries
- ▶ Operating Temperature: -20°C to 85°C
- ▶ Dimension: 85mm x 130mm



Edge Camera



Machine Learning



Computer Vision



Object/Image Recognition



Smart Retail / Smart checkout



Human Activity Recognition



Industrial Robotics

BLOCK DIAGRAM

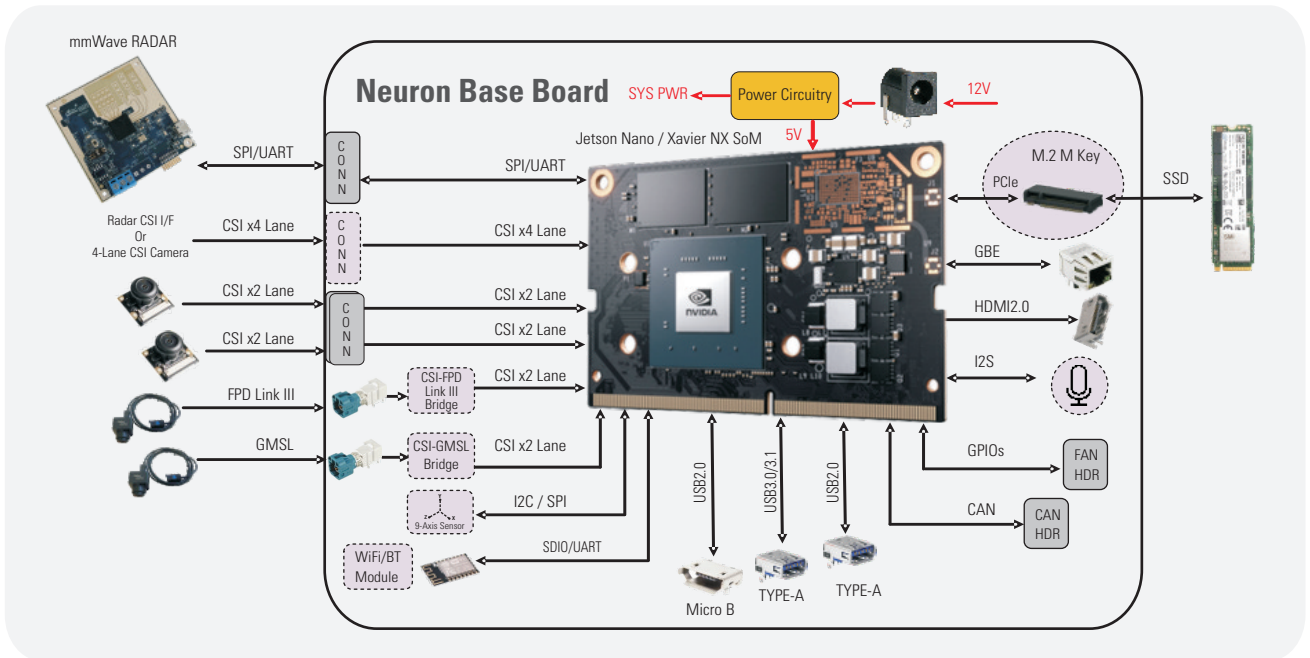

CUSTOMIZATION

In addition to providing engineering services for product/system development, Mistral also provides customization of Neuron Base Board to support:

- ▶ Camera RADAR Fusion
- ▶ Sensor Fusion
- ▶ Custom Camera Integration
- ▶ USB Expansion and USB Type-C
- ▶ Additional PCIe
- ▶ POE
- ▶ Application Software
- ▶ ML/DL Algorithms Development and Integration
- ▶ Audio and Video
- ▶ Cloud and Mobile Apps
- ▶ Power Optimization
- ▶ Mechanical Enclosure and Heat Sink Design

Mistral also provides product customization to support various peripheral, drivers and integration, multi-core SoC application development, FCC / CE certification, Thermal validation and system integration based on the customer need.

WHAT YOU WILL GET

- ▶ Neuron Base (with Jetson Nano/Jetson Xavier NX)
- ▶ Binary Images (Online) - Ubuntu Linux
- ▶ Quick Start Guide (Online)
- ▶ Software Package and User Manual (Online)

Mistral is a member of NVIDIA Partner Network and helps customers realize cutting edge products based on NVIDIA GPU computing solutions. Our product design services include hardware design, software design, firmware & BSP, ML/DL algorithm integration, audio & video, power and performance optimization and cloud and mobile apps.

Mistral Solutions Pvt. Ltd.,
 No.60, 'Adarsh Regent', 100 Feet Ring Road,
 Domlur Extension, Bangalore - 560 071
 Tel: +91-80-4562-1100
 E-mail: info@mistralsolutions.com

Mistral Solutions Inc.,
 43092 Christy Street
 Fremont, CA 94538, USA
 Tel: +1-408-705-2240
 E-mail: usa@mistralsolutions.com

MISTRAL
... Partners in Real Time
 www.mistralsolutions.com